

DESCRIPTION

ACCENT MOULDINGS

Cap Moulding

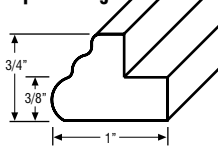

Light Rail Moulding

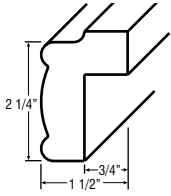

Soffit Trim Moulding

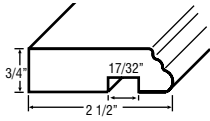

Triple Bead Moulding

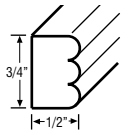

BASEBOARD

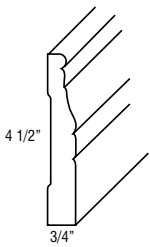

One 8' section.

DESCRIPTION

CONVEX



COUNTERTOP EDGE

Contemporary

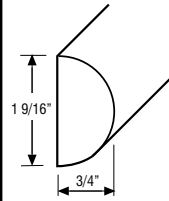

One 8' section.

Traditional

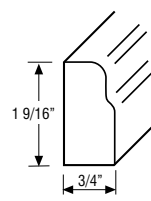

One 8' section.

CROWN

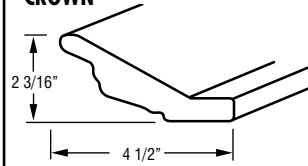

CONCAVE



DECORATIVE LEGS

French Leg

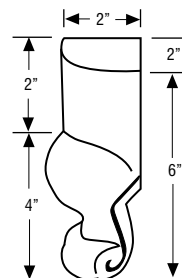

DESCRIPTION

DECORATIVE LEGS

Plinth Block

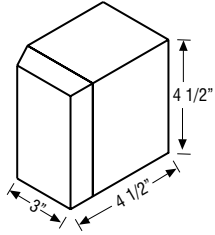

Reed

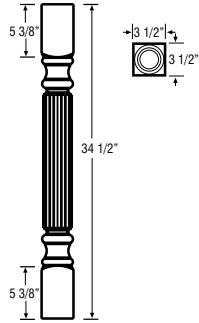

Spool

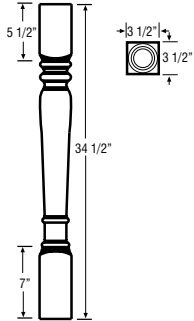

Tapered Leg

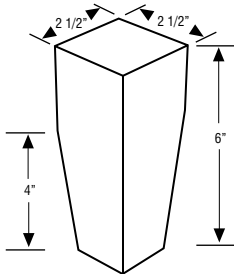

Tulip Foot

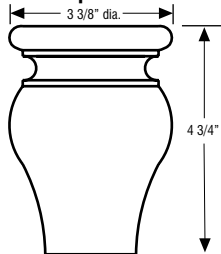

• Available in Maple and Cherry.

DESCRIPTION

DECORATIVE ORNAMENTS

Acanthus Ornament

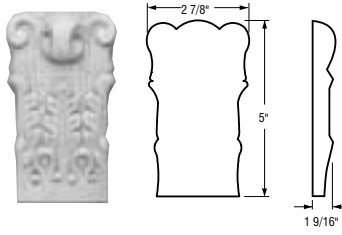

Grape Ornament

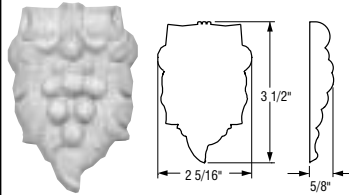

Shell Ornament

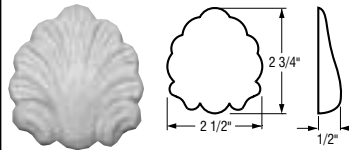

DECORATIVE OVERLAYS

Acanthus Overlay

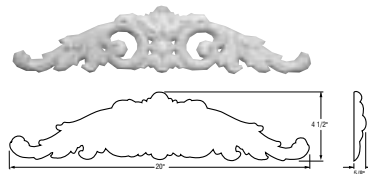

Grape Overlay

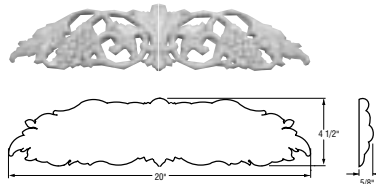

Shell Overlay

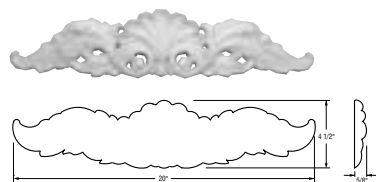

DESCRIPTION

DECORATIVE SHELF SUPPORTS

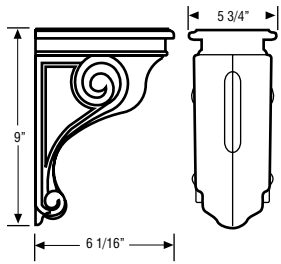
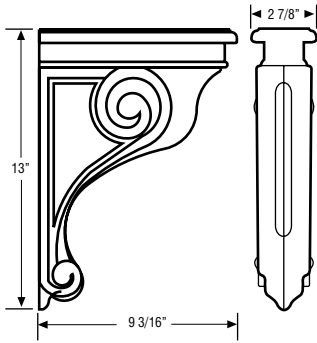

DECORATIVE SPLIT TURNINGS

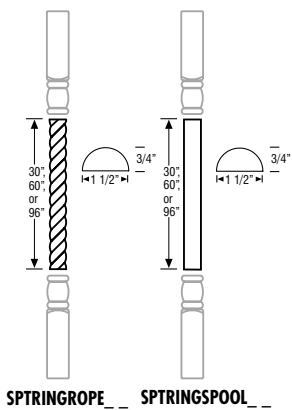
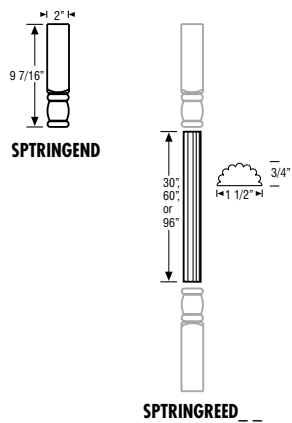

DENTIL

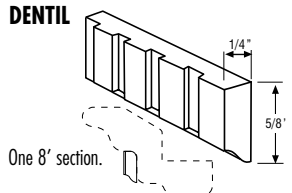

DESCRIPTION

DIAGONAL CORNER

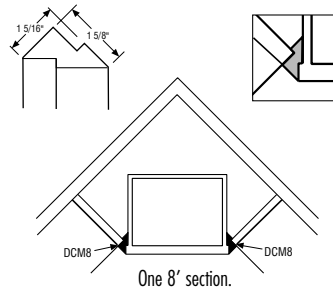

EGG & DART

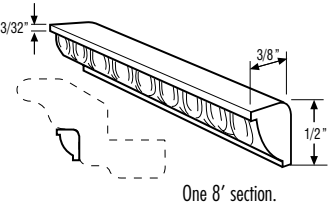

FLAT SCRIBE

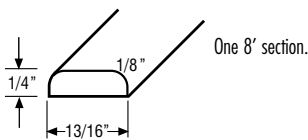

INSIDE CORNER

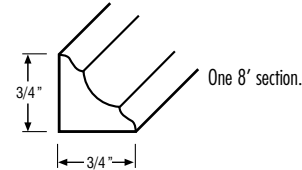

LIBRARY MOULDING

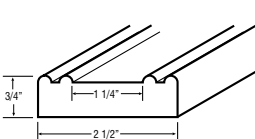

LIGHT BAFFLE

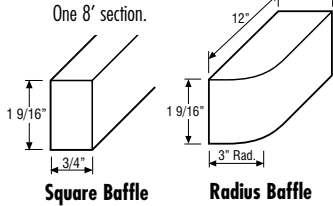

DESCRIPTION

MIRROR FRAME

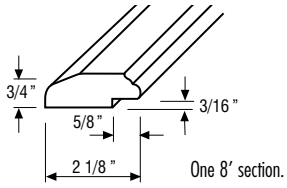

DESCRIPTION

ROPE

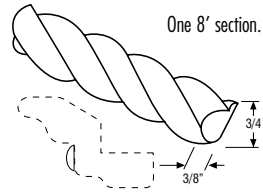

MOULDING INSERTS

Acanthus

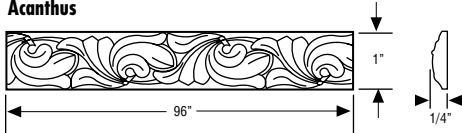

Braided

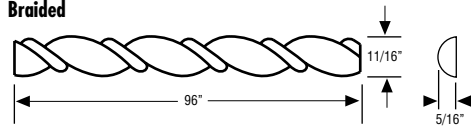

Greek/Aztec

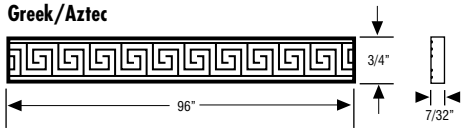

Ivy

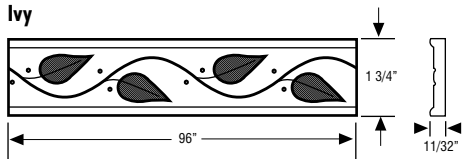

ROSETTE (Traditional)

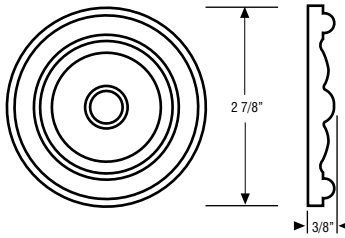

SHAKER CROWN

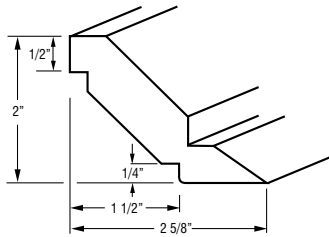

OUTSIDE CORNER

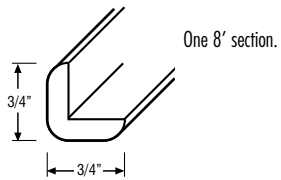

SHOE - CONVEX INSIDE CORNER

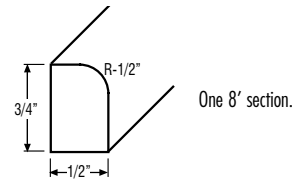
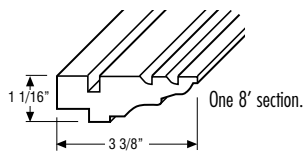
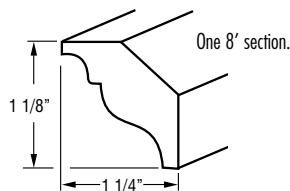

PLATE RAIL



SMALL CROWN



DESCRIPTION

SOLID WOOD CROWN

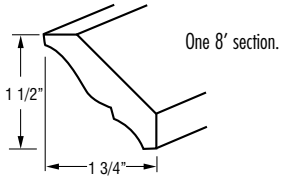

DESCRIPTION

VALLEY FORGE

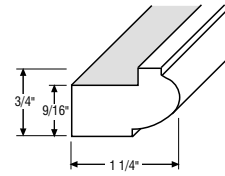

SOLID WOOD VICTORIAN CROWN

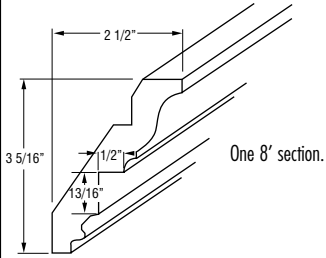

VICTORIAN CROWN

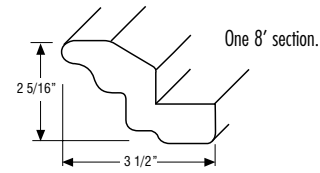

SPINDLE RAIL

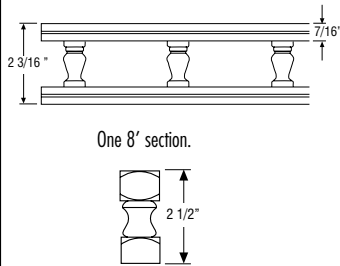

TRIPLE BEAD PILASTER

